

IBX-21

Technical Information InterBus-Box System

Please keep for further use !

Edition-/Rev.-Date: 08.02.1999
Document-/Rev.-No.: TRS - V - BA - GB - 0089 - 01
Soft edition:
File name: TRS-V-BA-GB-0089.DOC
Author: MÜJ

**TRSystemtechnik GmbH
Eglisshalde 6
D-78647 Trossingen**

Tel. 07425 / 228-0
Fax 07425 / 228-34

Imprint

TRSystemtechnik GmbH

D-78647 Trossingen
Eglishalde 6
Tel.: (+49) 07425/228-0
Fax: (+49) 07425/228-34

© Copyright 1998 TRSystemtechnik

Guarantee

In our ongoing efforts to improve our products, TR-Electronic reserve the right to alter the information contained in this document without prior notice.

Printing

This manual was edited using text formatting software on a DOS personal computer. The text was printed in *Arial*.

Fonts

Italics and bold type are used for the title of a document or to emphasize text passages.

Passages written in `Courier` show text which is visible on the screen / display as well as software menu selections.

"< >" refers to keys on your computer keyboard (e.g. <RETURN>).

Note

Text following the "NOTE" symbol DESCRIBES important features of the respective product.

Copyright Information ©

MS-DOS is a registered trademark of Microsoft Corporation.

Revision History

i

Note

The cover of this document shows the current revision status and the corresponding date. Since each individual page has its own revision status and date in the footer, there may be different revision statuses within the document.

Document created:

09.09.1998

Revision	Date
Module description MINC-2 (from version 1.02)	08.02.1999

Table of contents

1 The TRS Fieldbus System.....	5
2 Function Description of the IBX-21 Hardware	6
2.1 Front Panel Design.....	6
2.2 Configuration	6
2.3 Submodules	7
2.4 Status Messages.....	10
3 Installation Information	11
4 Terminal Assignments.....	11
5 Technical data	12
6 Type Code.....	13

1 The TRS Fieldbus System

TRS (TR-Systemtechnik) offers universal **I/O** boxes for different field bus systems. Using these boxes and an intelligent central module, you can solve complex open- and closed-loop control tasks. Each I/O box consists of a **basic module** containing four slots for fitting **submodules**. The table below shows possible fitting variants for existing submodules:

Submodule		Slot 1	Slot 2	Slot 3	Slot 4
MDI-8	8 digital inputs	NO	Yes	Yes	Yes
MDO-8	8 digital outputs, 24V/0.5 A	NO	Yes	Yes	Yes
MDM-8	8 digital outputs, 24V/2.0 A	NO	Yes	Yes	Yes
MAC-8	8 digital inputs, 110/220 V AC	NO	Yes	Yes	Yes
MDR-8	8 relays	NO	Yes	Yes	Yes
MDIO-16	16 digital in-/outputs	Yes	Yes	Yes	Yes
MAI-4	4 analog inputs, resolution: 12/16 bits	Yes	Yes	Yes	Yes
MAO-4	4 analog outputs, resolution: 16 bits	Yes	Yes	Yes	Yes
MSSI-2	2 synchronous serial interfaces	Yes	Yes	Yes	Yes
MINC-2	2 incremental encoders	Yes	Yes	Yes	Yes
MHAS-2	2 HAS encoders	Yes	Yes	Yes	Yes
MPWM-2	2 pulse width modulation outputs, 24V/2.0A	Yes	Yes	Yes	Yes

Submodule	Number of input words	Number of output words
MDI-8	1	1
MDO-8	1	1
MDM-8	1	1
MAC-8	1	1
MDR-8	1	1
MDIO-16	1	1
MAI-4	4	4
MAO-4	4	4
MSSI-2	4	4
MINC-2	4	4
MHAS-2	4	4
MPWM-2	4	4

Basic modules can be supplied for the following Fieldbus Systems:

Profibus-DP
 CAN-Bus (Device-Net)
 Lightbus
 INTERBUS-S

This document describes the IBX-21 INTERBUS-S Basic Module. Separate descriptions are available for the Basic Modules of other Fieldbus Systems.

2 Function Description of the IBX-21 Hardware

2.1 Front Panel Design

The front panel is equipped with a 9-pole SUB-D male connector X1 and a 9-pole SUB-D female connector X2. The connector X1 corresponds to the connection for the fieldbus input, X2 corresponds to the connection for the fieldbus output.

Figure 1

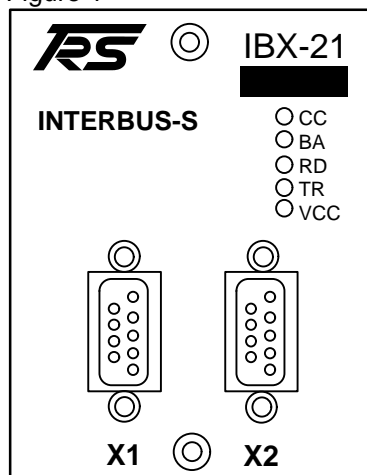

2.2 Configuration

03H (digital I/O) is always registered as a ident code of the INTERBUS-S.

The calculation of the telegram length in the IBX-21 is defined as follows:
(see also table on page 5)

- For bit-oriented submodules (MDX modules) and empty slots one output word and one input word is reserved.
- For byte-oriented submodules four output words and four input words are reserved.

The IBX-21 basic module searches the available submodules or empty slots and calculates the telegram length. Telegram length of 11, 13 or 15 words in the case of the INTERBUS are not permissible. Therefore the length is expanded on 12, 14 or 16 words.

Example:

Given equipment variant: 1xMAO4, 1xMDO8, 1xSSI2, 1xINC2

Telegram length:

	4 words	(MAO4)
+	1 word	(MDO8)
+	4 words	(SSI2)
+	4 words	(INC2)
	13 words	

Since 13 words are not permissible, 14 input words and 14 output words must be reserved.

2.3 Submodules

MDO 8

The 8 digital outputs need 1 word for writing the outputs. In the output word is only the low byte relevant.

MDI 8

The 8 digital inputs need 1 word for reading the inputs. In the input word is only the low byte relevant.

MDIO 16

The 16 digital inputs/outputs use 1 word for reading the inputs and 1 word for writing the outputs.

MSSI 2

This module has 2 SSI inputs. Each input has a maximum resolution of 25 bits. Data is output in Motorola format.

Message frame structure:

Channel 1 actual value				Channel 2 actual value			
MSB			LSB	MSB			LSB

MAI 4

The MAI 4 module has four analog inputs. Each analog input returns a 16-bit value. Data is output in Motorola format.

Message frame structure

Channel 1		Channel 2		Channel 3		Channel 4	
HByte	LByte	HByte	LByte	HByte	LByte	HByte	LByte

MAO 4

The MAO 4 module has four analog outputs. Each analog output is 16 bits in size. Data is input in Motorola format.

Message frame structure

Channel 1		Channel 2		Channel 3		Channel 4	
HByte	LByte	HByte	LByte	HByte	LByte	HByte	LByte

MINC 2 (from version 1.02)

This module has two incremental counter inputs. The counters return a maximum value of 25 bits. In addition, the two inputs have two inputs between them, i.e. one status and one command byte. A preset value to be transferred can be 25 bits in size.

Message frame structure input:

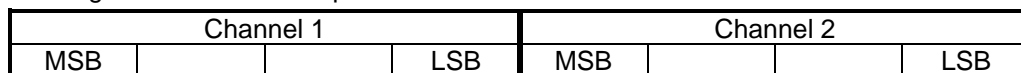

Controlbyte (MSB):

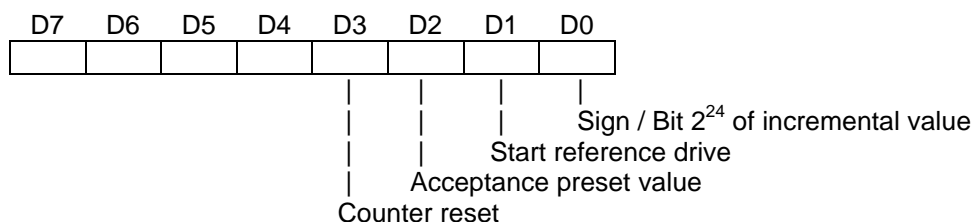

Message frame structure output:

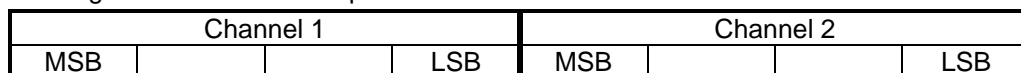

Statusbyte (MSB):

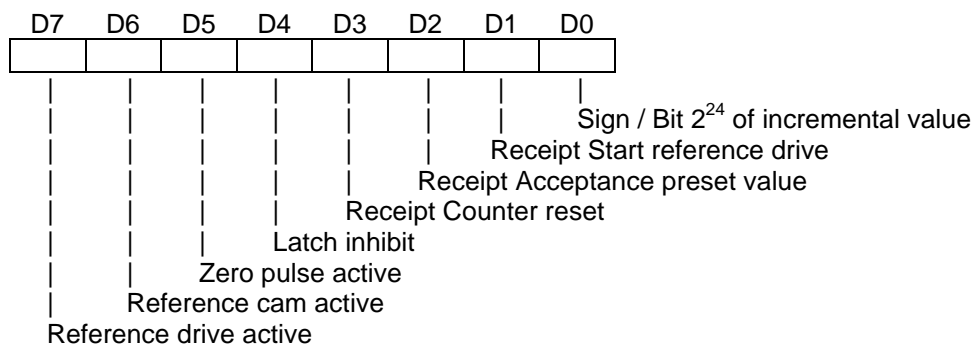

MPWM 2 (not available)

This module has two pulse width modulation outputs. The pulse wideness is input as a 16 bit-value.

Message frame structure input:

Channel 1				Channel 2			
STAT				STAT			

Statusbyte (STAT):

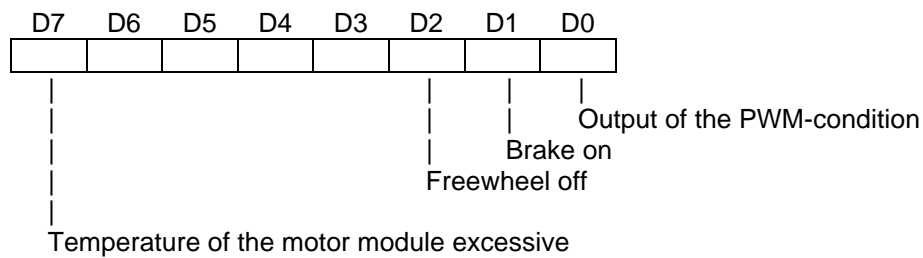

Message frame structure output:

Channel 1				Channel 2			
CTRL	TPER	Pulse wideness		CTRL	TPER	Pulse wideness	
		HByte	LByte			HByte	LByte

Controlbyte (CTRL):

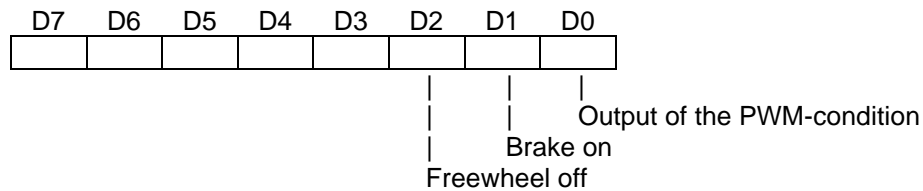

Cycle duration (TPER):

Informations cycle duration

MHAS 2 (not available)

This module has two HAS inputs. Each input has a resolution of 25 bits and a 16 bit error counter.

2.4 Status Messages

Corresponding of the INTERBUS S-specification the status of the module is indicated with the following LED'S:

LED	Color	Signification
CC	green	Cable Check <ul style="list-style-type: none"> ■ Lights up if cable connection is functional and the INTERBUS-S is not in reset
BA	green	Bus Active <ul style="list-style-type: none"> ■ Lights up if the INTERBUS-watchdog is not active
RD	red	Remotebus Disable <ul style="list-style-type: none"> ■ Lights up if the subsequent fieldbus is turned off ■ Is active in the state INTERBUS-RESET
TR	green	Transmit/Receive <ul style="list-style-type: none"> ■ Lights up if this device operates PCB communication (not available in this module)
VCC	green	Voltage supply monitoring

3 Installation Information

Mounting

You mount the IBX-21 in a decentralized position at the machine or in the switching cabinet by simply screwing it on to a mounting rail complying with DIN EN 50022 or DIN EN 50035.

4 Terminal Assignments

Connector X1, INTERBUS remote input (D-SUB male, 9 pin)

Pin	Signal	Meaning
1	DO1	+ Data line IN, incoming
2	DI1	+ Data line Out, outcoming
3	GNDI	GND incoming interface
4	NC	reserved
5	NC	reserved
6	/DO1	- Data line IN, incoming
7	/DI1	- Data line Out, outcoming
8	NC	reserved
9	NC	reserved

Connector X2, INTERBUS remote input (D-SUB female, 9 pin)

Pin	Signal	Meaning
1	DO2	+ data line OUT, incoming
2	DI2	+ data line IN, outcoming
3	GND	GND module and subsequent interface
4	NC	reserved
5	NC	+5V
6	/DO2	- Data line OUT, incoming
7	/DI2	- Data line IN, outcoming
8	NC	reserved
9	NC	RBST

Note:

If the remote bus output is occurred (further INTERBUS device), pin 9 must be connected with pin 5.

5 Technical data

Inputs/Outputs	Max. of 24 digital I/Os or max. of 16 analog I/Os, 8 SSIs, 8 incremental encoders, 8 HAS encoders, 8 PMW outputs or a mixture of galvanically decoupled submodules (max. of 4). Divided into 4 slots that can be fitted byte-by-byte with input or output modules (MDI, MDO, MDM, MAC, MDR) in slots 2, 3 and 4. (MAI, MAO, MSSSI, MINC, MHAS, MPWM) in slots 1, 2, 3 and 4. LED status indicator on all MD modules
Input Specifications	see input modules for IBX-21
Output Specifications	see output modules for IBX-21
Output Monitoring	Watchdog circuit
MDO8	INTERBUS, 9 pin SUB-D male and female connector
Interface	2-wire remote bus for INTERBUS-S, RS 422 with galvanic separation, binary
Identnumber	03H
Transfer Rate	300 kbaud net; 500 kbaud gross (inclusive control and status byte)
Supply voltage	24 V DC ($\pm 20\%$)
Current Consumption	Approx. 0.1 A (without submodules)
Housing	Closed, screw-mountable on mounting rail complying with DIN EN 50022, 50035
Dimensions (W x H x T)	315 x 76 x 68 mm
Weight	Approx. 750 g
Operating Temperature	$\pm 0..+55$ °C
Storage Temperature	-20..+70 °C

6 Type Code

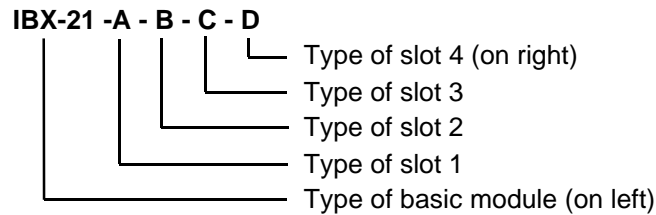

Type No.	Designation	Description
	IBX-21	INTERBUS-Box System, basic module for maximum of 4 Interface modules
Slot 1		MDIO16, MAI4, MAO4, MSSI2, MINC2, MHAS2, MPWM2
Slots 2, 3 & 4		MDI8, MDO8, MDM8, MDR8, MAC8 as well as MDIO16, MAI4, MAO4, MSSI2, MINC2, MHAS2, MPWM2
		Submodules:
-A	MAB	Cover plate instead of a submodule
-B	MDI8	Submodule, 8 digital inputs, 24 V DC
-C	MDO8	Submodule, 8 digital outputs 24 V DC/0.5A
-D	MDIO16	Submodule 16 digital in-/outputs
-E	MDR8-001	Submodule, 8 relays, same as "F", without suppressor circuit
-F	MDR8	Submodule, 8 relays, outputs, max. of 220 V AC/2.0A
-G	MAC8-110	Submodule, 8 digital AC inputs 110 V AC
-H	MAC8-220	Submodule, 8 digital AC inputs 220 V AC
-K	MDM8	Submodule, 8 digital DMOS power outputs 24V/2.0A
-L	MAI4-12	Submodule, 4 analog inputs
-N	MAI4-16	Submodule, 4 analog inputs
-M	MAO4	Submodule, 4 analog outputs
-O	MSSI-2	Submodule, 2 SSI interfaces
-P	MINC-2	Submodule, 2 incremental counters
-R	MHAS-2	Submodule, 2 high-speed asynchronous interfaces
-S	MPWM-2	Submodule, 2 pulse width modulation outputs 24 V/2.0 A
	Example:	Basic module fitted with (from left to right): 4 analog inputs 8 digital outputs, 24 V/0.5 A 8 digital outputs, 24 V/2.0 A Empty spare slot
	Order No. :	IBX-21-LCKA